

# MASADA ARMOUR



**YOUR SAFETY IS OUR MISSION**



**PRODUCT  
CATALOG  
2024**



# ABOUT US

---

**MASADA ARMOUR is a leading Israeli manufacturer of ballistic solutions and protective gear. With over two decades of commitment to safety, excellence & innovation, we provide reliable, cutting-edge products to protect our customers in the most demanding environments.**

Meaning “strong foundation or support” in Hebrew, MASADA is an ancient stone fortress in southern Israel’s Judean Desert, located high above the Dead Sea on a tall, rocky mesa. Built around 30 B.C.E, the complex is a well-preserved attestation to the history of the ancient kingdom of Israel and the courage of its people in the face of a Roman siege.

The fortress, in its structure and design, was, at the time, a sophisticated, innovative construction which provided safeguard against invaders.





## **YOUR SAFETY IS OUR MISSION**

At MASADA ARMOUR, our core values include being at the forefront of protective solutions by enabling our customers to face challenges with confidence. We strive to empower law enforcement, military personnel, security professionals, and individuals by offering state-of-the-art armour and protective gear that surpasses industry standards.

## **UNWAVERING COMMITMENT TO QUALITY**

We are dedicated to ensuring the highest level of quality in all of our products. Each panel of armour and tactical textile item undergoes stringent testing and adheres to strict quality control measures at our QA department, ensuring that it meets or exceeds international safety standards and regulations.

## **INNOVATION FOR A SAFER TOMORROW**

As pioneers in the industry, we invest in research and development to continuously innovate and stay ahead of emerging threats. Our in-house R&D department, along with a multinational team of experts and engineers, works tirelessly to explore new materials, manufacturing techniques and design approaches, pushing the boundaries of protective technology.

## **CUSTOMIZATION FOR INDIVIDUAL NEEDS**

Recognizing that every situation demands unique creativity, MASADA ARMOUR offers customization solutions for our products. Whether it's personal preferences, specific requirements along with high-end standards, our products can be tailored to fit your individual needs and safety.

## **CUSTOMER-CENTRIC APPROACH**

At MASADA ARMOUR, customer satisfaction and safety is at the core of everything we do. Our attentive and knowledgeable support team is always ready to assist you in selecting the suitable protective solutions, providing expert advice and addressing any queries promptly.

## **JOIN THE MASADA ARMOUR COMMUNITY**

Join our ever-growing global community of professionals and individuals who trust MASADA ARMOUR to protect them when it matters most. Explore our diverse catalog and experience the peace of mind that comes with wearing a world-class armour.



# CONTENT

## MAOZ LOAD BEARING

<b>DROR WARRIOR COMBAT KIT.....</b>	<b>1-2</b>
<b>COMPACT 6/COMPACT 8.....</b>	<b>3-4</b>
<b>ALMOG/OMER.....</b>	<b>5-6</b>
<b>PRESS.....</b>	<b>7-8</b>
<b>LEONARDO/VIP.....</b>	<b>9-10</b>
<b>PASHA/DAVID.....</b>	<b>11-12</b>
<b>TACTICAL ACCESSORIES.....</b>	<b>13-18</b>
<b>RAPTOR UNIFORM MK1.....</b>	<b>19-20</b>
<b>MASADA BACKPACKS.....</b>	<b>21-22</b>

## MACCABEE HELMET

<b>GIDEON HELMET.....</b>	<b>25-26</b>
<b>FAST HELMET.....</b>	<b>27-28</b>
<b>YOAV HELMET.....</b>	<b>29-30</b>
<b>MICH HELMET.....</b>	<b>31-32</b>
<b>MID CUT MICH HELMET.....</b>	<b>33-34</b>
<b>TACTICAL PASGT HELMET.....</b>	<b>35-36</b>
<b>PASGT HELMET.....</b>	<b>37-38</b>

## HOSHEN BODY ARMOUR

<b>LEVEL IIIA.....</b>	<b>41-42</b>
<b>LEVEL III+.....</b>	<b>43-44</b>
<b>LEVEL III++.....</b>	<b>45-46</b>
<b>LEVEL IV.....</b>	<b>47-48</b>

## MAOZ EOD

<b>BOMB SUIT 7800C.....</b>	<b>51-52</b>
<b>BOMB SUIT 2800C.....</b>	<b>53-54</b>
<b>DEMINEING SUIT.....</b>	<b>55-56</b>



# MAOZ

## LOAD BEARING SYSTEM





# DROR



## WARRIOR COMBAT KIT



## WARRIOR COMBAT KIT

# DROR



The **DROR WARRIOR COMBAT KIT** offers state-of-the-art protection based on our **COMPACT 8** and **COMPACT 6** Plate carriers. Part of the **MAOZ Load Bearing System**, the **DROR WARRIOR COMBAT KIT Full Coverage Tactical Vest** is designed for operators that require lightweight protective coverage and high-speed mobility. Engineered as a scalable ballistic platform with optional quick release functionality customizable Versatility. The set includes 11 modular components that seamlessly attach to any vest. Personalize your armor configuration to suit your specific needs, using the modules together or separately as required. The **DROR WARRIOR COMBAT KIT** offers a low-profile solution that is fully customizable with soft and hard armor inserts for mission-specific adaptability.

### Features:

- One Hand Tactical Quick Release Buckles.
- Front Zipper Document Pocket.
- Rear drag handle.
- 360° MOLLE Integrated system.
- L/R One-wrap shoulder strap for hydration & cable management.
- Fully adjustable cummerbund & shoulder straps to fit most sizes.

### Specs:

- Nylon 6/6 500D.
- MilSpec buckels & hardware.
- MilSpec hook & loop fasteners.
- MilSpec flat nylon webbing.
- Front, Rear & Shoulder 3D Spacer - mesh anti sweat
- 2D Milspec heavyweight mesh fabric.
- Fits 25X30cm (10"X12") / 28X35cm(11"X14" w/ compact 8) soft & hard armour inserts.

### Features:

- Neck & Throat armour module level IIIA/ 3A set
- Shoulders armour module level IIIA/3A set L/R
- Side armour module 15X20cm level IIIA/3A L/R
- Padded battle belt size M-L/L-XL
- Thigh armour module level IIIA/3A set L/R
- Groin armour module level IIIA/3A
- Buttocks armour module level IIIA/3A
- Additional MOLLE pouches are optional

### Specs:

- Nylon 6/6 500D.
- MilSpec buckels & hardware.
- MilSpec hook & loop fasteners.
- MilSpec flat nylon webbing.
- Inner 3D Spacer mesh anti sweat
- 2D Milspec heavyweight mesh fabric.
- Fits 15X15cm (6"X6") / 15X20cm(6"X8") soft & hard side armour inserts.

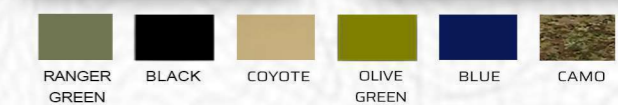
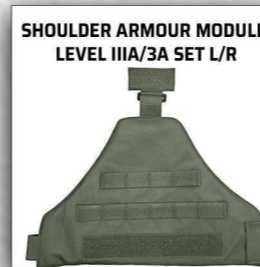

MAOZ LOAD BEARING SYSTEM

MAOZ LOAD BEARING SYSTEM



# COMPACT 6

## PLATE CARRIER



The Masada Armour **COMPACT 6 plate carrier** is the best choice for combat missions where weight is paramount and will not compromise safety or comfort. The fully modular 360° molle system gains maximum user flexibility to any need.

### Features:

- One Hand Tactical Quick Release Buckles.
- Front Zipper Document Pocket.
- Rear drag handle.
- 360° MOLLE Integrated system.
- L/R One-wrap shoulder strap for hydration & cable management.
- Fully adjustable cummerbund & shoulder straps to fit most sizes.

### Specs:

- Nylon 6/6 500D.
- MilSpec buckels & hardware.
- MilSpec hook & loop fasteners.
- MilSpec flat nylon webbing.
- Front, rear & shoulder 3D Spacer - mesh anti sweat
- 2D Milspec heavyweight mesh fabric.
- Fits 25X30cm (10"X12") soft & hard armour inserts.



**MASADA ARMOUR**  
YOUR SAFETY IS OUR MISSION



SKU: 2225000304

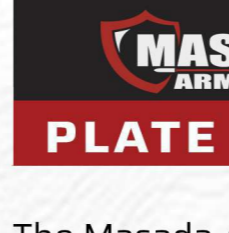

# COMPACT 8

## PLATE CARRIER



The Masada Armour **COMPACT 8 plate carrier** is the best choice for combat missions where weight is paramount and will not compromise safety or comfort. The fully modular 360° molle system gains maximum user flexibility to any need.

### Features:

- One Hand Tactical Quick Release Buckles.
- Front Zipper Document Pocket.
- Rear drag handle.
- 360° MOLLE Integrated system.
- L/R One-wrap shoulder strap for hydration & cable management.
- Fully adjustable cummerbund & shoulder straps to fit most sizes.

### Specs:

- Nylon 6/6 500D.
- MilSpec buckels & hardware.
- MilSpec hook & loop fasteners.
- MilSpec flat nylon webbing.
- Front, rear & shoulder 3D Spacer - mesh anti sweat.
- 2D Milspec heavyweight mesh fabric.
- Fits 28X35cm (11"X14") soft and hard armour inserts.



**MASADA ARMOUR**  
YOUR SAFETY IS OUR MISSION



SKU: 2225100404

MAOZ  
LOAD  
BEARING  
SYSTEM

MAOZ  
LOAD  
BEARING  
SYSTEM



# ALMOG



## BODY ARMOUR

The **Masada Armour ALMOG MOLLE BODY ARMOUR NIJ IIIA** is a versatile protective gear for military and paramilitary use. It meets NIJ standards. Its ergonomic design ensures a comfortable fit without limiting mobility, and the 360° molle system provides flexibility for various requirements.

### Features:

- Coverage Area front & back panels.
- **Sides panels are optional.**
- Level IIIA according to nij 0101.06.
- 360° MOLLE Integrated system.
- Front & back flat plate pocket for Hard plates
- Interior elastic belly belt and emergency drag handle.
- Fully adjustable shoulder straps and cummerbund with pockets for side armour to fit most sizes.
- Hook area in front and back For ID Patches
- Additional Option offers Upper Arm, Throat, Collar, Shoulder, Groin and Side when side plate inserted in external cummerbund, front and back hard plates.

### Specs:

- Nylon 6/6 500D.
- MilSpec buckels & hardware.
- MilSpec hook & loop fasteners.
- MilSpec flat nylon webbing.
- Front, back & shoulder 3D Spacer - mesh anti sweat
- Fit 25X30cm (10"X12") hard armour inserts
- Fit side plates 15X20cm (6"X8")



**MASADA ARMOUR**  
YOUR SAFETY IS OUR MISSION



SKU: 2226600302



## BULLETPROOF VEST

# OMER



The **Masada Armour OMER OVERT BULLETPROOF VEST NIJ IIIA** Bulletproof Vest is designed for paramilitary missions. The ergonomic design provides a smoother fit to the body without restricting movement, while still affording maximum coverage. The back and front pockets allow for the addition of protective plates and upgrade the level of protection.

### Features:

- Coverage Area front & back panels.
- **Sides panels are optional.**
- Level IIIA according to NIJ 0101.06
- Front & Rear flat plate pocket for Hard plates
- Fully adjustable cummerbund & shoulder straps to fit most sizes.

### Specs:

- Outer shell Polyester 600D.
- Water and oil resistant
- MilSpec hook & loop fasteners.
- MilSpec flat nylon webbing.
- Front & rear 3D spacer mesh anti sweat
- Fit 25X30cm (10"X12") hard armour inserts



**MASADA ARMOUR**  
YOUR SAFETY IS OUR MISSION



SKU: 2225100402

MAOZ LOAD BEARING SYSTEM

MAOZ LOAD BEARING SYSTEM





# PRESS



LIGHT OVERT BODY ARMOUR

Masada Armour's **LIGHT OVERT PRESS BODY ARMOUR NIJ IIIA** offers a comfortable and unrestricted fit to protect press personnel in hazardous locations. It has an ample coverage area that can be bolstered with protective plates. Developed with the intention of keeping journalists and television crews secure while in precarious surroundings, it provides an essential layer of defense.

### Features:

- Coverage Area front & back panels.
- Level IIIA according to NIJ 0101.06.
- Front & Rear flat plate pocket for Hard plates
- Removable front and rear PRESS reflective badges
- Front and back PRESS patches are included.
- Fixed front utility pouch
- Fully adjustable cummerbund & shoulder straps to fit most sizes

### Specs:

- Outer shell Polyester 600D.
- Water and oil resistant
- MilSpec hook & loop fasteners.
- MilSpec flat nylon webbing.
- Fit 25X30cm (10"X12") hard armour inserts



**MASADA ARMOUR**  
YOUR SAFETY IS OUR MISSION



SKU: 2228100303



# PRESS

OVERT BODY ARMOUR

Masada Armour's **OVERT PRESS BODY ARMOUR NIJ IIIA** offers a comfortable and unrestricted fit to protect press personnel in hazardous locations. It has an ample coverage area that can be bolstered with protective plates. Developed with the intention of keeping journalists and television crews secure while in precarious surroundings, it provides an essential layer of defense.

### Features:

- Neck & Throat armour module level IIIA/ 3A set
- Front & back level IIIA/3A inserts
- Groin armour module level IIIA/3A
- Level IIIA according to NIJ 0101.06.
- Front & Rear flat plate pocket for Hard plates
- Front wide load multipurpose pouch.
- Front and back PRESS patches are included
- Fully adjustable cummerbund & shoulder straps to fit most sizes

### Specs:

- Outer shell Polyester 600D.
- Water and oil resistant
- MilSpec hook & loop fasteners.
- MilSpec flat nylon webbing.
- Fit 25X30cm (10"X12") hard armour inserts



**MASADA ARMOUR**  
YOUR SAFETY IS OUR MISSION



SKU: 2226500303

MAOZ LOAD BEARING SYSTEM

MAOZ LOAD BEARING SYSTEM





# LEONARDO



## BULLETPROOF VEST

The **LEONARDO COVERT BULLETPROOF VEST NIJ IIIA** provides a superior combination of safety, convenience, and flexibility for law enforcement, the military, and private security. Manufactured with cutting-edge ballistic fabrics, it's unnoticeable and custom-made to be worn all day long overt and covert. Trust in its expertly-crafted quality, flexibility, and covert styling for peak performance

### Features:

- Maximum Concealment and Optimal Protection Coverage.
- Low Profile concealed Bulletproof Vest
- Inner front & rear flat plate pocket for Hard plates
- Ergonomical Design for Freedom of Movement
- 4 Points Full Adjustment by Waist and Shoulder Straps.
- Extremely lightweight and flexible
- Arrives work-ready

### Specs:

- Outer shell nylon 70D honeycomb rip stop.
- PVC coated,
- Water and oil resistant
- Level IIIA according to NIJ 0101.06.
- MilSpec hook & loop fasteners.
- Inner front & rear 2D spacer mesh anti sweat.
- Fit 25X30cm (10"X12") hard armour inserts.



**MASADA ARMOUR**  
YOUR SAFETY IS OUR MISSION

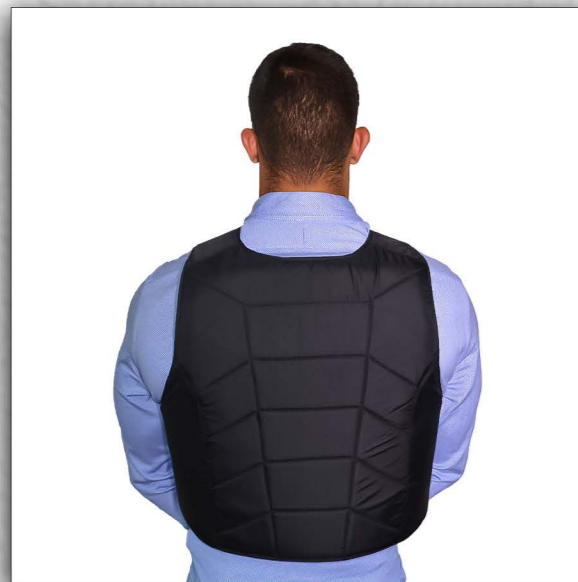

SKU: 2227000302



# VIP COVERT

## BULLETPROOF VEST

The **VIP COVERT BULLETPROOF VEST NIJ IIIA** is a first-rate protection solution that combines comfort, style, and effectiveness, crafted specifically for VIPs, dignitaries, and high-profile individuals. Its superior ballistic materials offer great flexibility and weight balance, while its discreet low-profile design provides optimal privacy. It also features a custom fit, allowing for optimal comfort when worn for extended periods. This vest is the epitome of craftsmanship, offering remarkable adaptability and impenetrable protection

### Features:

- Maximum Concealment and Optimal Protection Coverage.
- Low Profile concealed Bulletproof Vest
- Inner front & rear flat plate pocket for Hard plates
- Ergonomical Design for Freedom of Movement
- 4 Points Full Adjustment by Waist and Shoulder Straps.
- Extremely lightweight and flexible
- Arrives work-ready

### Specs:

- Outer shell Lightweight Stretch polycotton Fabric
- Level IIIA according to NIJ 0101.06.
- MilSpec hook & loop fasteners.
- Inner front & rear 3D spacer mesh anti sweat.
- Fit 25X30cm (10"X12") hard armour inserts.
- Size available S-3XL



**MASADA ARMOUR**  
YOUR SAFETY IS OUR MISSION

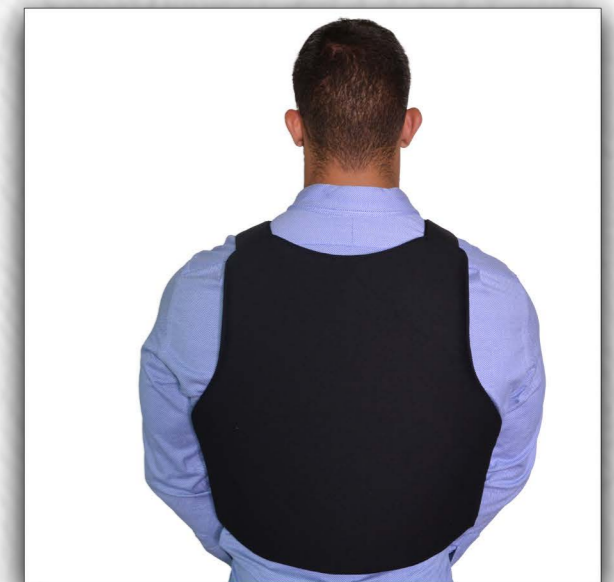
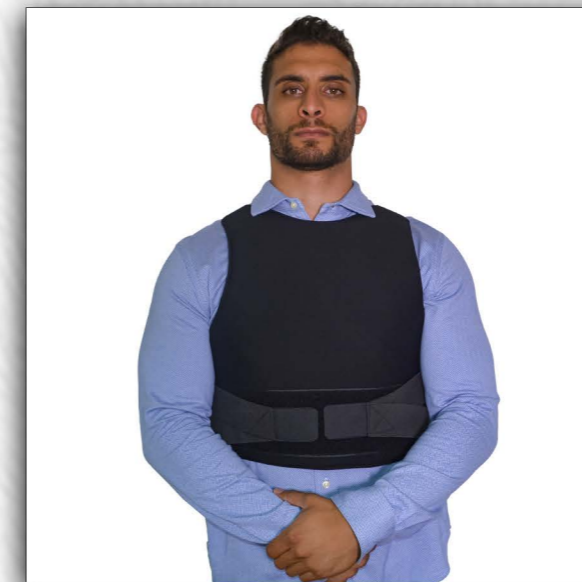

SKU: 2210000302

MAOZ  
LOAD  
BEARING  
SYSTEM

MAOZ  
LOAD  
BEARING  
SYSTEM



# PASHA



## MULTI POCKET MESH VEST

The **PAHSA MULTI POCKET MESH VEST** is a great choice for a wide range of tactical situations as LE and military personnel who need a lightweight and comfortable vest that can be easily customized.

The **PAHSA MULTI POCKET MESH VEST** is a lightweight and breathable tactical vest made from durable MilSpec heavyweight mesh fabric. It features tough side adjustment straps for a comfortable and secure fit. The rear panel is fitted with sturdy horizontal PALS loops for attaching ID panels or pouches, and the vest also has PALS webbing throughout the vest allows for easy customization.

### Features:

- Fixed vertical admin pouches.
- Four fixed universal pouches
- Two fixed pistol mag/tool pouches.
- Inner pocket for hydration bladder
- Side adjustment straps with ladder locks.
- Front and Rear hook-and-loop ID panels.
- Tactical load-bearing vest for special operations and Law Enforcement
- Lightweight and comfortable to wear
- One size fits most

### Specs:

- 2D MilSpec heavyweight mesh fabric.
- Inner 3D Spacer mesh anti sweat.
- MilSpec hook & loop fasteners.
- MilSpec flat nylon webbing.
- YKK Zipper



**MASADA ARMOUR**  
YOUR SAFETY IS OUR MISSION



SKU: 2226100304



# DAVID

## MOLLE MESH VEST

The **David MOLLE Mesh Vest** is a great choice for a wide range of tactical situations as law enforcement and military personnel who need a lightweight and comfortable vest that can be easily customized.

The **David MOLLE Mesh Vest** is a lightweight and breathable tactical vest made from durable polyester mesh. It features tough side adjustment straps and shoulder length adjusters for a comfortable and secure fit.

The rear panel is fitted with sturdy horizontal PALS loops for attaching ID panels or pouches, and the vest also comes with two full-size chest pockets and a sturdy emergency drag handle. The PALS webbing throughout the vest allows for easy customization.

### Features:

- 360° MOLLE Integrated system.
- Two full size internal front pockets secured with YKK zippers with zip pulls
- Inner pocket for hydration bladder
- Side adjustment straps with ladder locks.
- Rear drag handle.
- Front hook-and-loop ID panels with PALS webbing
- Tactical load-bearing vest for special operations
- Lightweight and comfortable to wear
- One size fits most

### Specs:

- 2D MilSpec heavyweight mesh fabric.
- Inner 3D Spacer mesh anti sweat.
- MilSpec buckles & hardware.
- MilSpec hook & loop fasteners.
- MilSpec flat nylon webbing.
- YKK Zipper



**MASADA ARMOUR**  
YOUR SAFETY IS OUR MISSION



SKU: 2226800304



MAOZ  
LOAD  
BEARING  
SYSTEM

MAOZ  
LOAD  
BEARING  
SYSTEM

### HORIZONTAL ADMIN POUCH



SKU: 6630700304 16x20x4.5cm

### ADMIN HORIZONTAL POUCH XL



SKU: 6632400404 16x23x4.5cm

### VERTICAL ADMIN POUCH



SKU: 6630800304 20x14x6cm

### SOF IFAK POUCH



SKU: 6632200304 18x12x6.5cm

### TOURNIQUET POUCH



SKU: 6631300304 13x5x4.5cm

### TACTICAL MEDIC POUCH



SKU: 6632300304 16x12x7.5cm

### MOTO ARP RADIO POUCH



SKU: 6632300304 13x5x4cm

### 624/710 MBITR RADIO POUCH



SKU: 6630300304 22x8x6cm

### FRAG GRENADE POUCH



SKU: 6630600304 11x8x5cm

### FLASHBANG / TOOL POUCH



SKU: 6631100304 13x5x5.5cm

### SIDE PLATE POCKET



SKU: 2227900304 20X16.5X3cm

### 3L HYDRATION POUCH



SKU: 6631600304 40X23X8cm

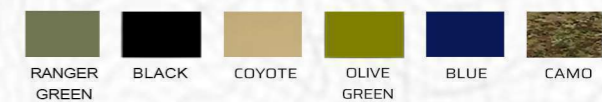



MAOZ  
LOAD  
BEARING  
SYSTEM

### SOF MODULAR RIFLE SLING



SKU: 90103500304 48x7cm

### PATROL MODULAR RIFLE SLING



SKU: 90103600304 51x8cm

### NEGEV HD MODULAR RIFLE SLING



SKU: 90103700304 52x12cm

### NVG MODULAR STRAP



SKU: 6632000304 20x4cm

### MINI MOLLE DROP LEG PLATFORM



SKU: 2228700204 18x8cm

### MOLLE DROP LEG PLATFORM



SKU: 2228300304 25x24cm

### PADDED BATTLE BELT M-L



SKU: 6631800204 84x11cm

### PADDED BATTLE BELT L-XL



SKU: 6631900404 110x11cm

### BALLISTIC HELMET COVER



SKU: 90102200402 OSFA

### SOF BALLISTIC HELMET COVER



SKU: 90103900304 OSFA

### MOLLE PISTOL HOLSTER L



SKU: 66312100304 19x9x2.5cm

### MOLLE PISTOL HOLSTER R



SKU: 6631200304 19x9x2.5cm



MAOZ  
LOAD  
BEARING  
SYSTEM



MAOZ  
LOAD  
BEARING  
SYSTEM

### SINGLE PISTOL MAG POUCH



SKU: 6630700304 11x4.5x2.5cm

### DOUBLE PISTOL MAG POUCH



SKU: 6630400304 10.5x10.5x3cm

### SINGLE 5.56/9MM MAG POUCH



SKU: 6631400304 13x8x6cm

### SINGLE 5.56 MAG POUCH



SKU: 6631000304 13x9x3cm

### DOUBLE 5.56 MAG POUCH



SKU: 6631500304 13x9x6cm

### TRIPLE 5.56 MAG POUCH



SKU: 6631700304 15.5x23x4cm

### DOUBLE AK/M4 MAG POUCH



SKU: 6632100304 12x9x6cm



MAOZ  
LOAD  
BEARING  
SYSTEM



# RAPTOR MK1

COMBAT UNIFORM



COMBAT UNIFORM

# RAPTOR MK1



Introducing the Raptor Combat Uniform MK1

Developed by **MASADA ARMOUR** in collaboration with **KEELA** Company, the Raptor Combat Uniform MK1 is the pinnacle of combat apparel.

This uniform utilizes cutting-edge materials and construction techniques to deliver exceptional durability, breathability, and comfort in the most demanding environments. Our unique fabric combination offers enhanced protection and flexibility, allowing for optimal performance in the field.

### RAPTOR SHIRT SPECS:

- Anti sweat body fabric: Quick dry ADS KEELA
- Mil-Spec NYCO 50/50 ripstop
- YKK® zippers
- Shell Fabric :100% Polyester (Body)
- Shell Fabric : 65% polyester 35% cotton Fabric ( Sleeve & Collar) Lining Fabric :Fusible Paper Lining
- Lining Fabric: 2.5mm Neoprene
- Size Range : S - 2XL

### RAPTOR SHIRT FEATURES:

- Front zipper
- Low-profile bicep pocket
- Loop insignia panel on sleeve pockets
- Contoured low-profile elbow pad configuration
- Gusseted cuffs



In cm		S	M	L	XL	2XL	Tol +/-
A	Chest width 1" down armhole	98cm	104cm	112cm	120cm	128cm	1
B	Back Length	76cm	77cm	78cm	79cm	80cm	1
C	Sleeve Length - C/B to cuff	87.5cm	89.5cm	92cm	94.5cm	97cm	1
D	Bottom Hem	92cm	98cm	104cm	114cm	120cm	1

### RAPTOR PANTS FEATURES: RAPTOR PADS SPECS:

- 2 large cargo pockets with stitched draining points
- Designed for use with our removable RAPTOR MK1 Knee Pad
- Kevlar fabric over knee pocket, only neoprene pad inside knee pocket .
- Extended zip fly
- No-snap button closure
- Double layer seat
- Boot hooks and lower leg ties
- Temperature stable, Near infra-red protection
- Quick-drying,
- UV protection
- EN ISO 15025:2002 requirements, limited flame spread, surface ignition
- ISO 4649:2010 despite no pass/fail requirements
- ISO 20345:2011 meet when compared
- Care&Maitenance: wipe-clean only, using a damp cloth; Do not bleach; Do not dry clean; Do not wash

### RAPTOR PANTS SPECS:

- Mil-Spec NYCO 50/50 ripstop
- YKK® zippers
- Super fabric
- Shell Fabric: 65% Polyester 35% cotton fabric Lining Fabric: Fusible Paper Lining
- Size Range - S - 2XL
- Weight 64g
- Thickness 8 mm
- Dimensions 260 mm x 180 mm

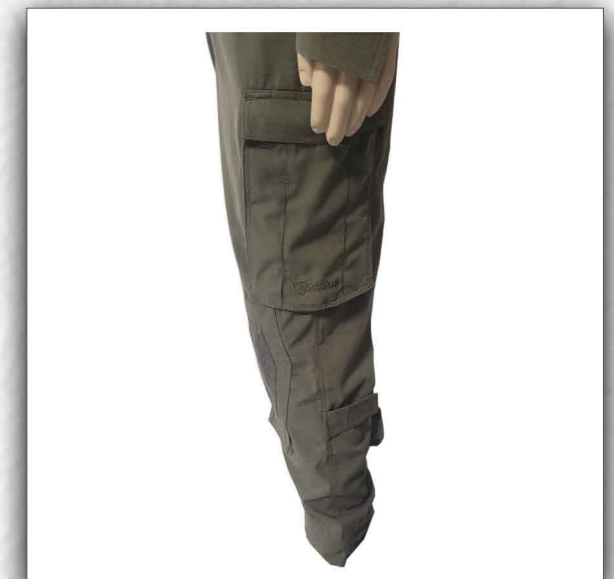

**MASADA ARMOUR**  
YOUR SAFETY IS OUR MISSION



SKU: 9010680402

MAOZ LOAD BEARING SYSTEM

MAOZ LOAD BEARING SYSTEM



# MASADA BULLETPROOF BACKPACK



NIJ IIIA

The **Masada Bulletproof Backpack Full Body Armor Bulletproof Vest NIJ IIIA** looks deceptively innocent on the outside, yet with the flip of a switch it transforms into a bulletproof vest within seconds. Suitable for both civilians and law enforcement personnel alike, the Masada Backpack offers level IIIA protection panels that protect against handgun rounds. Additionally, the vest can be upgraded to withstand rifle fire. In its standard form, it can be used as a regular backpack for carrying everyday items such as books, a laptop, etc. With its separate compartment, the wearer is assured 100% concealment when accessing the standard compartment for their EDC items.

### Features:

- Coverage Area front & back and side panels.
- Level IIIA according to nij 0101.06 IIIA.
- Front & back flat plate pocket for Hard plates.
- Easy and fast deployment.
- Adjustable Shoulder and waist straps.
- Laptop storage compartment.
- Ergonomic design.
- Designed specially for students.
- Carry handle.
- Padded shoulders.
- Fullback cushioning for comfort.
- Lots of pockets and smaller compartments.

### Specs:

- Polyester 600D.
- MilSpec buckles & hardware.
- MilSpec hook & loop fasteners.
- MilSpec flat nylon webbing.
- YKK zippers
- Front, rear & shoulder 3D Spacer mesh anti sweat.
- Fits 25X30cm (10"X12") hard armour inserts.



## MASADA ARMOUR

YOUR SAFETY IS OUR MISSION



SKU: 5589300302



# MASADA BULLETPROOF TACTICAL BACKPACK

NIJ IIIA

The **Masada Tactical Bulletproof Backpack Full Body Armor Bulletproof Vest NIJ IIIA** may appear ordinary at first glance, yet it is capable of being rapidly converted into a bulletproof vest with the press of a button. Suitable for civilians, law enforcement, special operations, and military personnel, the Masada Backpack offers level IIIA protection against handgun rounds. Additionally, the vest can be further upgraded to resist rifle fire. Furthermore, the pack functions as an everyday backpack with a spacious main compartment featuring molle integration, as well as a separate compartment for items that require absolute concealment.

### Features:

- Coverage Area front & back and side panels.
- Level IIIA according to nij 0101.06 IIIA.
- Front & back flat plate pocket for Hard plates.
- 360° MOLLE Integrated system
- Easy and fast deployment.
- Adjustable Shoulder and waist straps.
- Laptop storage compartment.
- Ergonomic design.
- Main storage compartment is MOLLE integrated
- Carry handle.
- Padded shoulders.
- Fullback cushioning for comfort.
- Lots of pockets and smaller compartments.

### Specs:

- Nylon 6/6 500D.
- MilSpec buckles & hardware.
- MilSpec hook & loop fasteners.
- MilSpec flat nylon webbing.
- YKK zippers
- Front, rear & shoulder 3D Spacer mesh anti sweat.
- Fits 25X30cm (10"X12") hard armour inserts.



## MASADA ARMOUR

YOUR SAFETY IS OUR MISSION



SKU: 5589600302



MAOZ LOAD BEARING SYSTEM

MAOZ LOAD BEARING SYSTEM





# MACCABEE

## HELMET





# GIDEON



## IIIA BALLISTIC HELMET

Masada Armour GIDEON Helmet designed for military and police use, offers exceptional lightweight protection against ballistic and fragmentation threats. Featuring a comfortable and adjustable harness system, the helmet ensures a personalized fit for individual needs. The four-point harness, secured with ballistic-resistant bolts, allows for easy cleaning or replacement.

GIDEON HELMET SIZE	M	L	XL
Head Cir. (cm)	54-55	56-57	58-59
PE Weight(kg)	1.20 ± 5%	1.25 ± 5%	1.35 ± 5%



**MASADA ARMOUR**   
**YOUR SAFETY IS OUR MISSION**

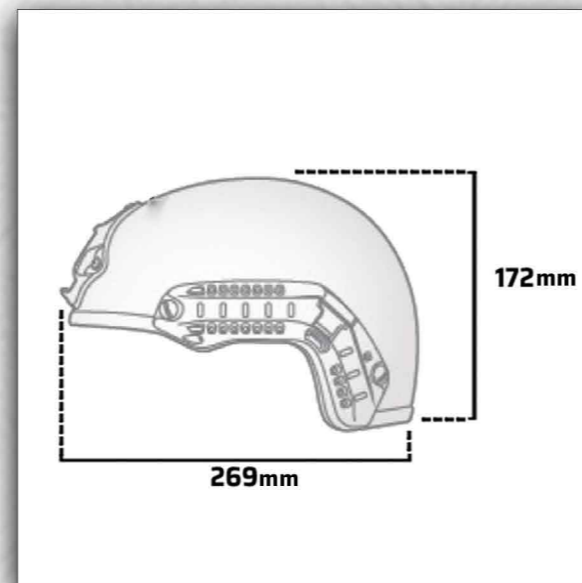

SKU: 4468000204



# GIDEON



## IIIA BALLISTIC HELMET

### BALLISTIC PERFORMANCE:

- LEVEL IIIA ACCORDING TO NIJ 0106.01/AR-PD 14.01
- FRAGMENTS PROTECTION: STANG 2920
- 17 GRAIN V50 > 750 M/S ACCORDING TO MIL-STD-662F
- TRAUMA < 25

### SHELL SPECS:

- SHELL THICKNESS: 7.5MM
- FINISHED SHELL NOMINAL WEIGHT: +-1.05kg
- MATERIAL: UHMW-PE FIBER.



**MASADA ARMOUR**   
**YOUR SAFETY IS OUR MISSION**



M  
A  
C  
C  
A  
B  
E  
E  
H  
E  
L  
M  
E  
T

M  
A  
C  
C  
A  
B  
E  
E  
H  
E  
L  
M  
E  
T



# FAST



## IIIA BALLISTIC HELMET

The Masada armour FAST BALLISTIC HELMET is a combat helmet that is used by special forces willing to use an alternate headgear while using some ballistic protection for comfortable headwear to use. The Fast is a special operator helmet, manufactured using advanced UHMW-PE composites. This lightweight robust helmet provides protection against ballistic and fragmentation projectiles. The helmet is equipped with a 4-point adjustable Harness. The helmet is fitted with a universal night vision goggle mount and Picatinny rails that provide a solid platform for flashlights, optics, and other gear.

FAST HELMET SIZE	M	L	XL
Head Cir. (cm)	54-55	56-57	58-59
Kevlar Weight(kg)	1.40 ± 5%	1.55 ± 5%	1.60 ± 5%
PE Weight(kg)	1.30 ± 5%	1.35 ± 5%	1.40 ± 5%



**MASADA ARMOUR**   
 YOUR SAFETY IS OUR MISSION

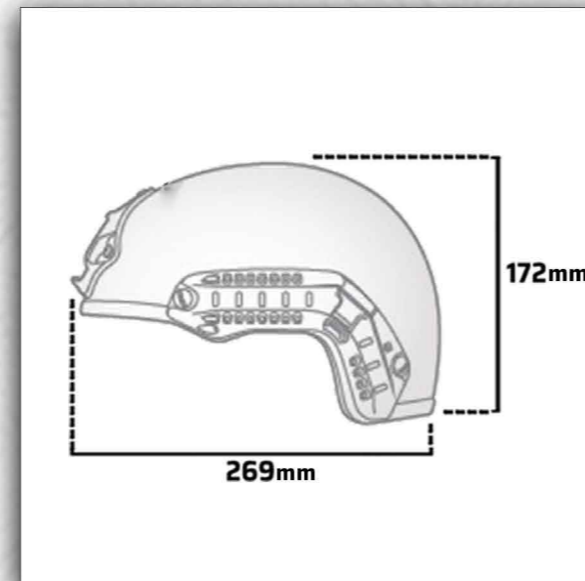

SKU: 4466800302



# FAST



## IIIA BALLISTIC HELMET

### BALLISTIC PERFORMANCE:

- LEVEL IIIA ACCORDING TO NIJ 0106.01
- FRAGMENTS PRTOTACTION: STANG 2920
- 17 GRAIN V50 > 650 M/S ACCORDING TO MIL-STD-662F
- TRAUMA < 25

### SHELL SPECS:

- SHELL THICKNES: 8MM
- FINISHED SHELL NOMINAL WEIGHT: +-1.2kg
- MATERIAL: UHMW-PE FIBER / KEVLAR.



**MASADA ARMOUR**   
 YOUR SAFETY IS OUR MISSION

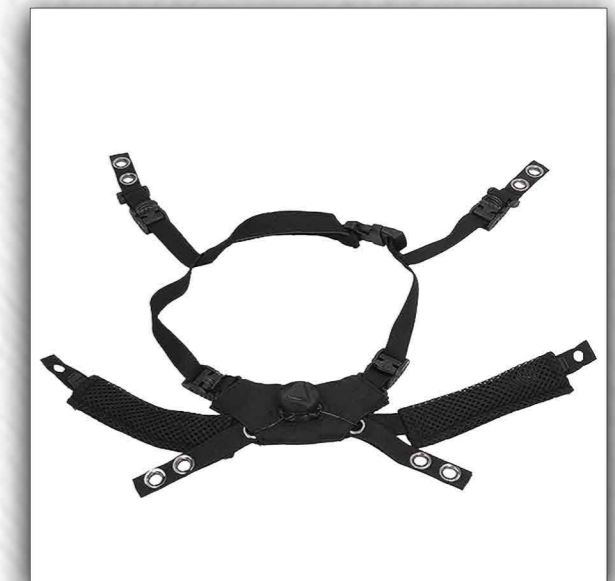

M  
A  
C  
C  
A  
B  
E  
E  
H  
E  
L  
M  
E  
T

M  
A  
C  
C  
A  
B  
E  
E  
H  
E  
L  
M  
E  
T



# YOAV



## IIIA BALLISTIC HELMET

MASADA ARMOUR'S YOAV Helmet is made out of the highest quality materials. The YOAV is a special operator helmet, manufactured using advanced UHMW-PE composites. This lightweight robust helmet provides protection against ballistic & fragmentation projectiles. The helmet is equipped with a 4-point adjustable Harness. The helmet is fitted with a universal night vision goggle mount and Picatinny rails that provide a solid platform for flashlights, optics, and other gear.

YOAV HELMET SIZE	M	L	XL
Head Cir. (cm)	54-55	56-57	58-59
Kevlar Weight(kg)	1.40 ± 5%	1.55 ± 5%	1.60 ± 5%
PE Weight(kg)	1.30 ± 5%	1.35 ± 5%	1.40 ± 5%



# YOAV

## IIIA BALLISTIC HELMET

### BALLISTIC PERFORMANCE:

- LEVEL IIIA ACCORDING TO NIJ 0106.01
- FRAGMENTS PRTOTACTION: STANG 2920
- 17 GRAIN V50 > 650 M/S ACCORDING TO MIL-STD-662F
- TRAUMA < 25

### SHELL SPECS:

- SHELL THICKNES: 8MM
- FINISHED SHELL NOMINAL WEIGHT: +-1.2kg
- MATERIAL: UHMW-PE FIBER / KEVLAR.

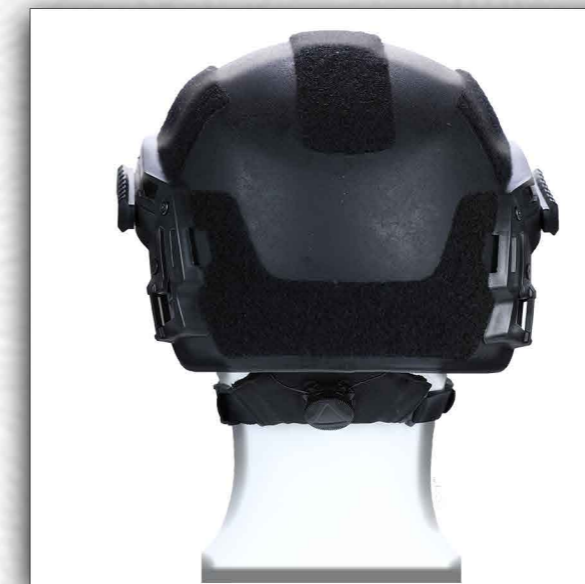

**MASADA ARMOUR**   
YOUR SAFETY IS OUR MISSION

**MASADA ARMOUR**   
YOUR SAFETY IS OUR MISSION

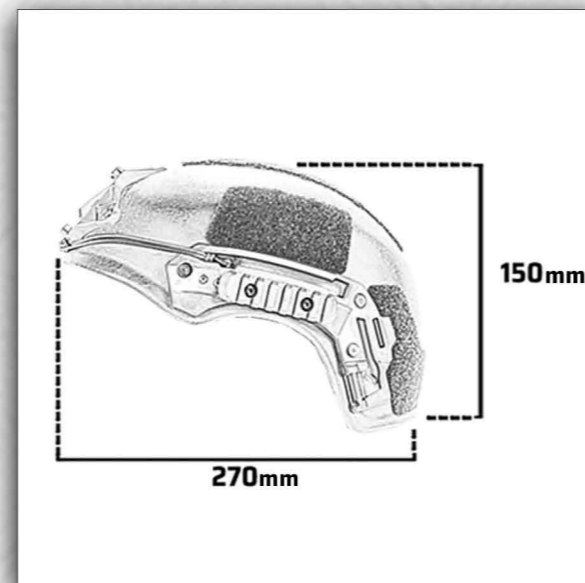

SKU: 4468000202

M  
A  
C  
C  
A  
B  
E  
E  
H  
E  
L  
M  
E  
T

M  
A  
C  
C  
A  
B  
E  
E  
H  
E  
L  
M  
E  
T



# MICH



## IIIA BALLISTIC HELMET

MASADA ARMOUR's MICH helmet is the next-gen combat helmet meeting U.S. Army requirements. It's lightweight, compatible with gear like communication equipment and night vision devices, and provides robust protection against small arms and explosives. With secure attachment straps and inner padding, it offers stability and comfort.

MICH HELMET SIZE	M	L	XL
Head Cir. (cm)	54-55	56-57	58-59
Kevlar Weight(kg)	1.50 ± 5%	1.55 ± 5%	1.60 ± 5%
PE Weight(kg)	1.40 ± 5%	1.45 ± 5%	1.50 ± 5%



**MASADA ARMOUR**  
YOUR SAFETY IS OUR MISSION

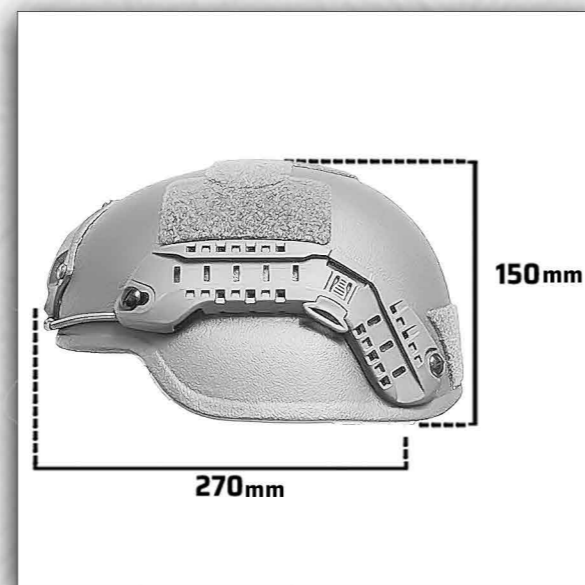
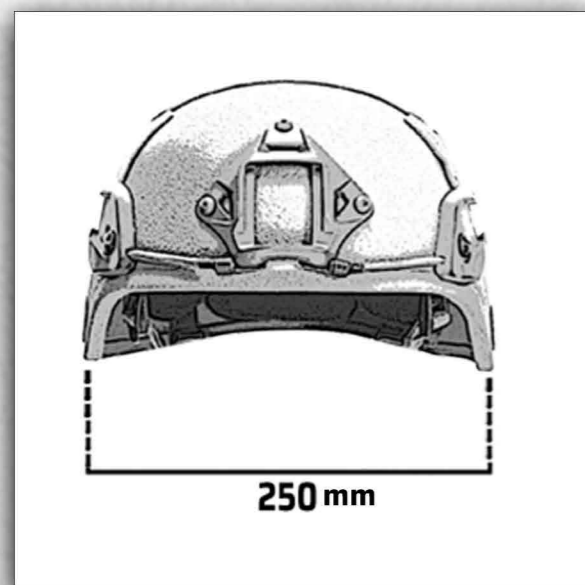

SKU: 4466800304



# MICH

## IIIA BALLISTIC HELMET

### BALLISTIC PERFORMANCE:

- LEVEL IIIA ACCORDING TO NIJ 0106.01
- FRAGMENTS PROTECTION: STANG 2920
- 17 GRAIN V50 > 650 M/S ACCORDING TO MIL-STD-662F
- TRAUMA < 25

### SHELL SPECS:

- SHELL THICKNESS: 8MM
- FINISHED SHELL NOMINAL WEIGHT: +-1.2kg
- MATERIAL: UHMW-PE FIBER / KEVLAR.

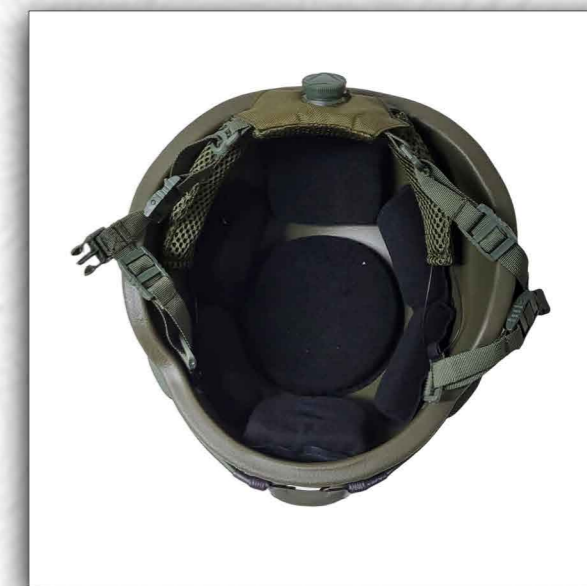

**MASADA ARMOUR**  
YOUR SAFETY IS OUR MISSION

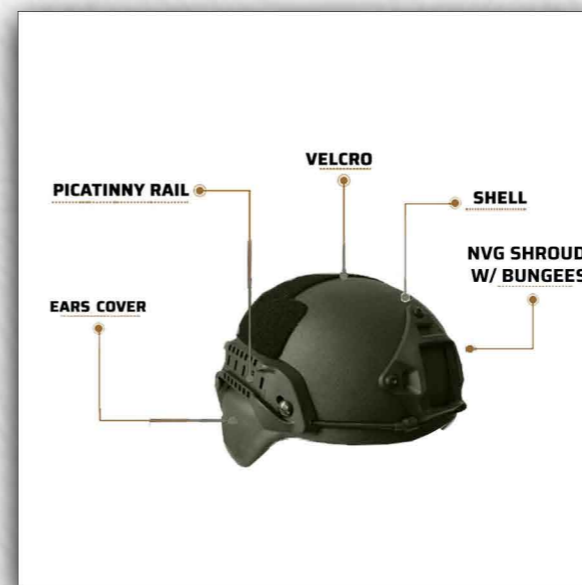

M  
A  
C  
C  
A  
B  
E  
E  
H  
E  
L  
M  
E  
T

M  
A  
C  
C  
A  
B  
E  
E  
H  
E  
L  
M  
E  
T





# MID CUT MICH



IIIA BALLISTIC HELMET

The MID CUT MICH helmet is the next-gen combat helmet meeting U.S. Army requirements. It's lightweight, compatible with gear like communication equipment and night vision devices, and provides robust protection against small arms and explosives. With secure attachment straps and inner padding, it offers stability and comfort.

MID CUT MICH HELMET SIZE	M	L	XL
Head Cir. (cm)	54-55	56-57	58-59
Kevlar Weight(kg)	1.45 ± 5%	1.50 ± 5%	1.55 ± 5%
PE Weight(kg)	1.35 ± 5%	1.40 ± 5%	1.45 ± 5%



# MID CUT MICH



IIIA BALLISTIC HELMET

### BALLISTIC PERFORMANCE:

- LEVEL IIIA ACCORDING TO NIJ 0106.01
- FRAGMENTS PRTOTACTION: STANG 2920
- 17 GRAIN V50 > 650 M/S ACCORDING TO MIL-STD-662F
- TRAUMA < 25

### SHELL SPECS:

- SHELL THICKNES: 8MM
- FINISHED SHELL NOMINAL WEIGHT: +-1.2kg
- MATERIAL: UHMW-PE FIBER / KEVLAR.



MASADA ARMOUR   
YOUR SAFETY IS OUR MISSION

MASADA ARMOUR   
YOUR SAFETY IS OUR MISSION

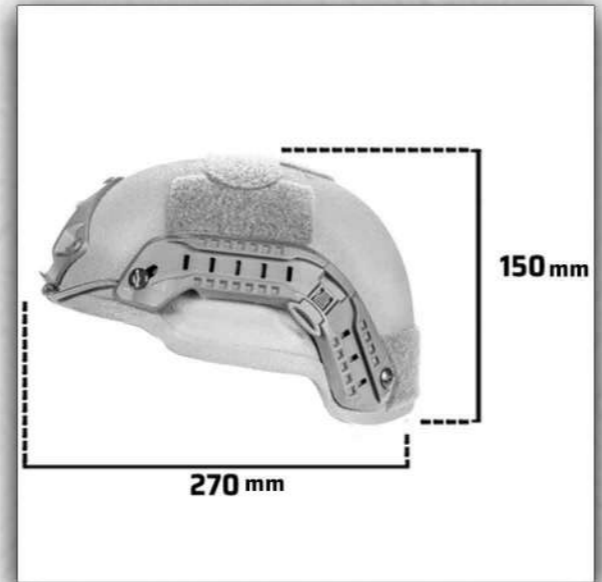

SKU: 4472400308

M  
A  
C  
C  
A  
B  
E  
E  
H  
E  
L  
M  
E  
T

M  
A  
C  
C  
A  
B  
E  
E  
H  
E  
L  
M  
E  
T



# TACTICAL PASGT

IIIA BALLISTIC HELMET



Masada Armour TACTICAL PASGT Helmet: UHMW-PE helmet, designed for military and police use, offers exceptional lightweight protection against ballistic and fragmentation threats. Featuring a comfortable and adjustable harness system, the helmet ensures a personalized fit for individual needs. The four-point harness, secured with ballistic-resistant bolts, allows for easy cleaning or replacement.

TACTICAL PASGT HELMET SIZE	M	L	XL
Head Cir. (cm)	54-55	56-57	58-59
Kevlar Weight(kg)	1.60 ± 5%	1.65 ± 5%	1.70 ± 5%
PE Weight(kg)	1.50 ± 5%	1.55 ± 5%	1.60 ± 5%



IIIA BALLISTIC HELMET

# TACTICAL PASGT



### BALLISTIC PERFORMANCE:

- LEVEL IIIA ACCORDING TO NIJ 0106.01
- FRAGMENTS PRTOTACTION: STANG 2920
- 17 GRAIN V50 > 650 M/S ACCORDING TO MIL-STD-662F
- TRAUMA < 25

### SHELL SPECS:

- SHELL THICKNES: 8MM
- FINISHED SHELL NOMINAL WEIGHT: +-1.2kg
- MATERIAL: UHMW-PE FIBER / KEVLAR.



**MASADA ARMOUR**   
 YOUR SAFETY IS OUR MISSION

**MASADA ARMOUR**   
 YOUR SAFETY IS OUR MISSION

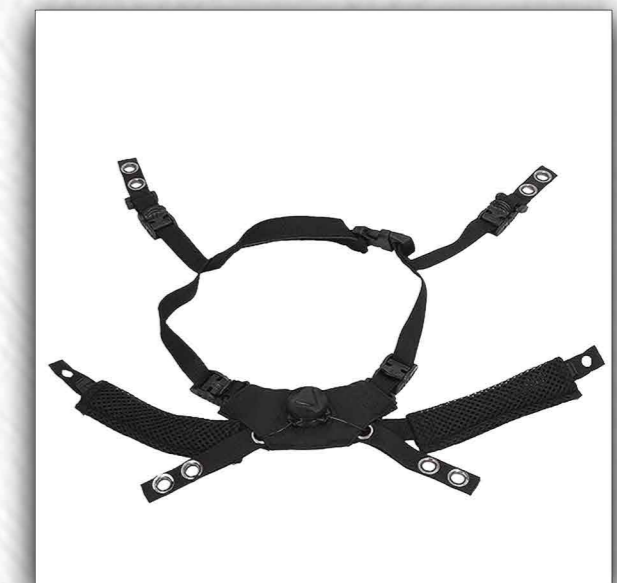
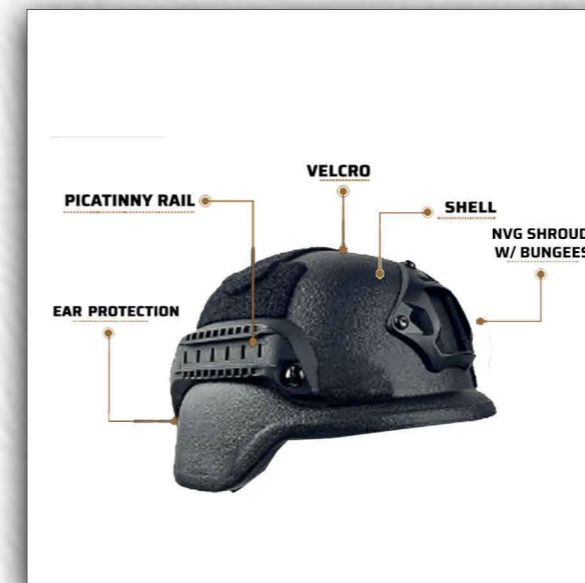

SKU: 4468000202

M  
A  
C  
C  
A  
B  
E  
E  
H  
E  
L  
M  
E  
T

M  
A  
C  
C  
A  
B  
E  
E  
H  
E  
L  
M  
E  
T



# PASGT



## IIIA BALLISTIC HELMET

Masada Armour PASGT Helmet: UHMW-PE helmet, designed for military and police use, offers exceptional lightweight protection against ballistic and fragmentation threats. Featuring a comfortable and adjustable harness system, the helmet ensures a personalized fit for individual needs. The four-point harness, secured with ballistic-resistant bolts, allows for easy cleaning or replacement.

PASGT HELMET SIZE	M	L	XL
Head Cir. (cm)	54-55	56-57	58-59
Kevlar Weight(kg)	1.50 ± 5%	1.55 ± 5%	1.60 ± 5%
PE Weight(kg)	1.40 ± 5%	1.45 ± 5%	1.50 ± 5%



# PASGT

## IIIA BALLISTIC HELMET

### BALLISTIC PERFORMANCE:

- LEVEL IIIA ACCORDING TO NIJ 0106.01
- FRAGMENTS PRTOTACTION: STANG 2920
- 17 GRAIN V50>650 M/S ACCORDING TO MIL-STD-662F
- TRAUMA<25

### SHELL SPECS:

- SHELL THICKNES: 8MM
- FINISHED SHELL NOMINAL WEIGHT: +-1.2kg
- MATERIAL: UHMW-PE FIBER / KEVLAR.

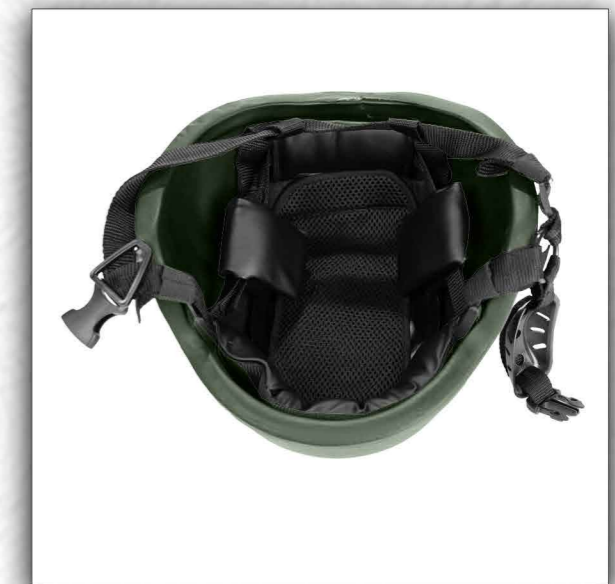

**MASADA ARMOUR**   
**YOUR SAFETY IS OUR MISSION**

**MASADA ARMOUR**   
**YOUR SAFETY IS OUR MISSION**

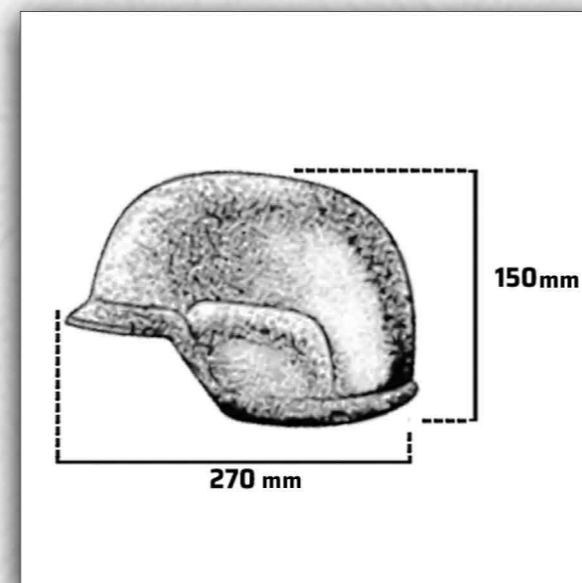

SKU: 4466600204

M  
A  
C  
C  
A  
B  
E  
E  
H  
E  
L  
M  
E  
T

M  
A  
C  
C  
A  
B  
E  
E  
H  
E  
L  
M  
E  
T





# HOSHEN BODY ARMOUR





# LEVEL IIIA

- **Ballistic Protection : IAW NIJ STD 0101.06 LEVEL IIIA**
- **Protects: .357 SIG FMJ FN 125gr (448m), 9mm Luger FMJ RN 124gr(448m) .44 Mag semi JACKETED HP (SJHP) 240gr (435m)**
- **Minimal hit distance from the edge: 51mm**
- **Shooting Distance 5m**

- **Covering: PU 420 NAYLON**
- **Thickness: 8mm**
- **Made with UHMW-PE**
- **Engineered for comfort and maneuverability**
- **Ultra concealable**
- **Available in custom cuts**



**MASADA ARMOUR**  
YOUR SAFETY IS OUR MISSION



**MASADA ARMOUR**  
YOUR SAFETY IS OUR MISSION







# LEVEL III+

- **Ballistic Protection : IAW NIJ STD 0101.06 LEVEL III+**
- **Max number of shots: X6**  
5.56X45(M193),AK47 7.62X39 MSC, M80 7.62X51 NATO
- **Minimal hit distance from the edge: 75mm**
- **Shooting Distance 15m**
- **Specs detailed for STA only**

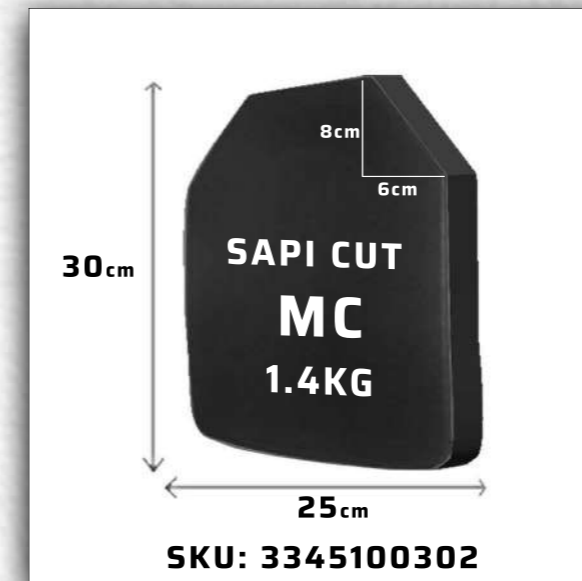
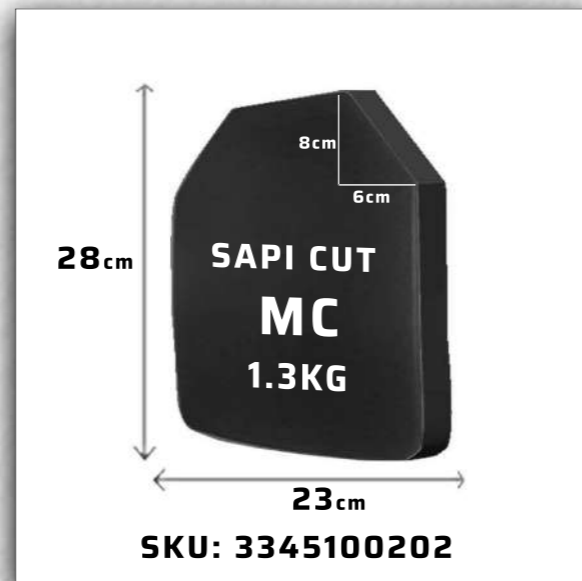
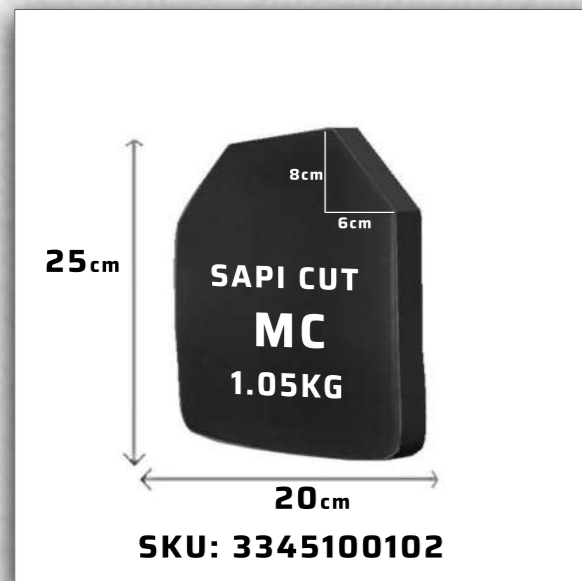
- **Finishing: Black fabric cover / PU coating**
- **Thickness: 22mm**
- **Made with UHMW-PE**
- **Avialable in STA and ICW**
- **Avialable in Multi Curve and Single Curve**



**MASADA ARMOUR**  
YOUR SAFETY IS OUR MISSION



**MASADA ARMOUR**  
YOUR SAFETY IS OUR MISSION

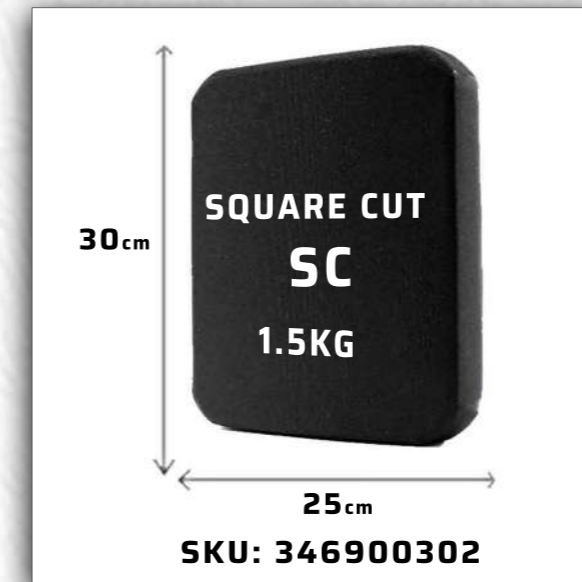
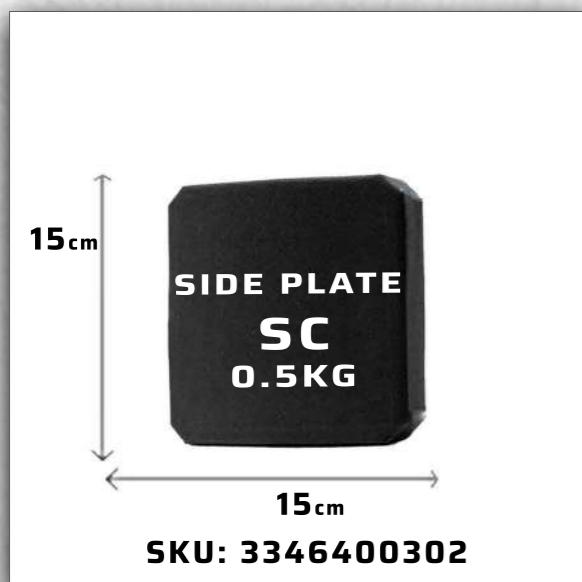

# LEVEL III++

- Ballistic Protection : IAW NIJ STD 0101.06 LEVEL III++
- Max number of shots: X6  
5.56X45(M193), NATO 5.56X45(SS 109 M855),AK47 7.62X39 MSC, M80 7.62X51 NATO
- Minimal hit distance from the edge: 75mm
- Shooting Distance 15m

- Finishing: Black fabric cover / PU coating
- Thickness: 22mm
- Made with ceramic and UHMW-PE
- Available in STA and ICW
- Available in Multi Curve and Single Curve

### AL2O3

SIZE L



30cm  
20cm

SAPI CUT MC  
2.3 KG

SKU: 3345400302

SIZE XL



35cm  
28cm

SAPI CUT MC  
2.9 KG

SKU: 3345400402

### SiC

SIZE L



30cm  
20cm

SAPI CUT MC  
1.95 KG

SKU: 3347600302

SIZE XL



35cm  
28cm

SAPI CUT MC  
2.6 KG

SKU: 3347600402

### B4C

SIZE L



30cm  
20cm

SAPI CUT MC  
1.8 KG

SKU: 3347700302

SIZE XL



35cm  
28cm

SAPI CUT MC  
2.4 KG

SKU: 3347700402

15cm  
15cm

SIDE PLATE SC  
0.75 KG

SKU: 3345400102

20cm  
15cm

SIDE PLATE SC  
0.9 KG

SKU: 3345400202

15cm  
15cm

SIDE PLATE SC  
0.65 KG

SKU: 3347600102

20cm  
15cm

SIDE PLATE SC  
0.8 KG

SKU: 3347600202

15cm  
15cm

SIDE PLATE SC  
0.6 KG

SKU: 3347700102

20cm  
15cm

SIDE PLATE SC  
0.75 KG

SKU: 3347700202





# LEVEL IV

- Ballistic Protection : IAW NIJ STD 0101.06 LEVEL IV
- Max number of shots: 7.62X63mm M2AP X1 shot
- Minimal hit distance from the edge: 75mm
- Shooting Distance 15m
- Specs detailed for STA only

- Finishing: Black fabric cover / PU coating
- Thickness: 24mm
- Made with ceramic and UHMW-PE
- Available in STA and ICW
- Available in Multi Curve and Single Curve

### AL2O3

**SIZE L**

SAPI CUT MC  
2.9 KG

SKU: 3346700302

**SIZE XL**

SAPI CUT MC  
3.5 KG

SKU: 3346700402

### SiC

**SIZE L**

SAPI CUT MC  
2.7 KG

SKU: 3347400302

**SIZE XL**

SAPI CUT MC  
3.3 KG

SKU: 3347400402

### B4C

**SIZE L**

SAPI CUT MC  
2.4 KG

SKU: 3347500302

**SIZE XL**

SAPI CUT MC  
3.0 KG

SKU: 3347500402

**SIDE PLATE SC**

0.9 KG

SKU: 3346700102

**SIDE PLATE SC**

1.25 KG

SKU: 3346700202

**SIDE PLATE SC**

0.8 KG

SKU: 3347400102

**SIDE PLATE SC**

1.1 KG

SKU: 3347400202

**SIDE PLATE SC**

0.7 KG

SKU: 3347500102

**SIDE PLATE SC**

1.0 KG

SKU: 3347500202





**LEVEL IV**  
RIFLE PROTECTION



**LEVEL III++**  
RIFLE PROTECTION



**LEVEL III+**  
RIFLE PROTECTION



**LEVEL IIIA**  
HANDGUN PROTECTION





# MAOZ

## EOD





# BOMB SUIT 7800C

## EOD



## EOD

# BOMB SUIT 7800C



The Masada Armour **EOD-7800C full body Bomb Suit** is designed specifically for Bomb Technicians and EOD experts, delivering maximum protection with enhanced flexibility and ventilation. It features an ergonomic design to provide unrestricted movement and easy operation of related tools. Utilizing the latest materials and techniques, this suit offers customizable armour protection tailored to each individual situation. A water repellent Aramid construction, an anti-trauma layer, and resilient, closed cell, linear foam all contribute to the armor's defense, while a high-strength, UV stabilized fabric covers the outer shell.

### Features:

- Front and back protection
- Neck and throat protector with ballistic plate.
- Chest and groin ballistic plate.
- Sleeves with removable hand protectors.
- Rear pocket for airflow system batteries and communication system.
- Spine protector is optional
- Quick release is optional.
- Cooling inserts are optional.

### Features:

- Vest module
- Trousers module
- Ballistic Hard plates
- Helmet with Visor
- Overshoes module

### Specs:

- Suit Front side: V50 550m'/s'
- Suit Rear side: V50 450m'/s'
- Suit Front with Ballistic hard Plate 1400m'/s'
- Sleeves: V50 450m'/s'
- Helmet and visor V50 550m'/s'
- Overshoes V50 450m'/s'
- Weight: 25 kg.



**MASADA ARMOUR**  
YOUR SAFETY IS OUR MISSION



MAOZ  
LOAD  
BEARING  
SYSTEM

MAOZ  
LOAD  
BEARING  
SYSTEM







# BOMB SUIT 2800C



## EOD



## EOD

# BOMB SUIT 2800C



The Masada Armour **EOD-2800C** is a lightweight protective suit tailored to the needs of bomb technicians and Explosive Ordnance Disposal experts. The latest materials and methods of manufacture are utilized to create a suit which provides optimal protection without sacrificing flexibility or ventilation. Multiple layers of soft Aramid repel water, and are contained within a waterproof outer shell for extra protection. Additionally, anti-trauma layers are integrated into the armor packs. To guard against heat and UV rays, the exterior of the suit is crafted from a flame-resistant material of superior durability.

### Features:

- Vest with removable sleeves
- Trousers module
- Other protection level can be offered per client request.
- PASGT helmet with ballistic visor is optional
- Weight: 16 kg

### Specs:

- Nylon 6/6 500D.
- Made with Aramid/Polyethylene
- Front, back & shoulder 3D Spacer -mesh anti sweat
- Protection Level: Upper body + Trousers V50 580m/s for 17grain fragment.
- Sleeves and Overshoes 450m/s for 17grain fragment.
- Chest area: level III
- Ballistic Hard plate level III size 25\*30cm'

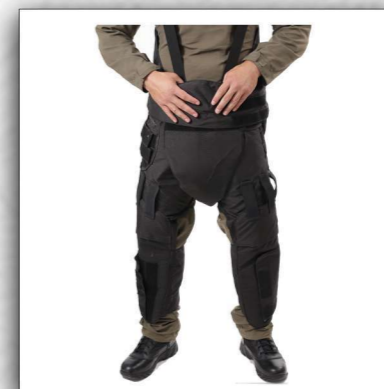

**MASADA ARMOUR**  
YOUR SAFETY IS OUR MISSION



MAOZ  
LOAD  
BEARING  
SYSTEM

MAOZ  
LOAD  
BEARING  
SYSTEM





# DEMINING SUIT



# DEMINING SUIT



The Masada Armour **Demining Suit** is an ergonomic and versatile piece of Personal Protective Equipment, designed to ensure maximum comfort while guaranteeing impenetrable protection from anti-personnel mines. The Suit adheres to UN International Mine Action Standards (IMAS) and covers the neck, shoulders, torso, groin and thighs. An optional arm protector can also be installed. Divided into two parts, the Suit allows the wearer to perform demanding work in the field while enabling optimum flexibility and air ventilation. In addition, the ballistic inserts are easily removable and the cover can be cleaned in a washing machine.

### Features:

- Made of three parts, upper, lower and sandal platform
- Developed and tested in the field with deminers operating in extreme conditions.
- Causes minimum restriction to movement and vision.
- Provides maximum air ventilation.
- Ballistic inserts can be easily removed.
- Outer cover can be washed in a washing machine.

### Specs:

- STANAG 2920 V50 Rating 450 m/s, IMAS 10.30
- MIL-662F for 17 grain fragments < 450 m/s.
- A protection against 17 grain fragments up to 580 m/s can be provided upon special request.
- PASGT helmet with ballistic visor is optional



**MASADA ARMOUR**  
YOUR SAFETY IS OUR MISSION



MAOZ  
LOAD  
BEARING  
SYSTEM

MAOZ  
LOAD  
BEARING  
SYSTEM

# MASADA ARMOUR



**YOUR SAFETY IS OUR MISSION**

## CONTACT US

HEADQUARTERS

PHONE: +972-4-653-8586

FAX: +972-4-699-5413

EL ZEIT 6, INDUSTRIAL AREA, JULIS, ISRAEL 2490800

## VISIT US



[WWW.MASADA-ARMOUR.COM](http://WWW.MASADA-ARMOUR.COM)